

Data sheet | Item number: 832-1104/037-000

1-conductor female plug; 100% protected against mismatching; lever; Silver-plated contacts; Locking lever; 16 mm²; Pin spacing 10.16 mm; 4-pole; 16,00 mm²; light gray

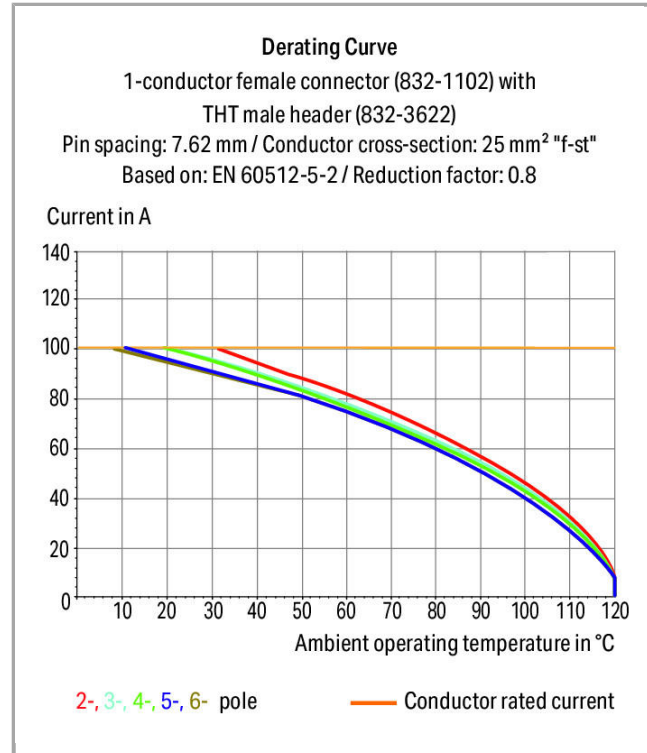

832-1104_037-000



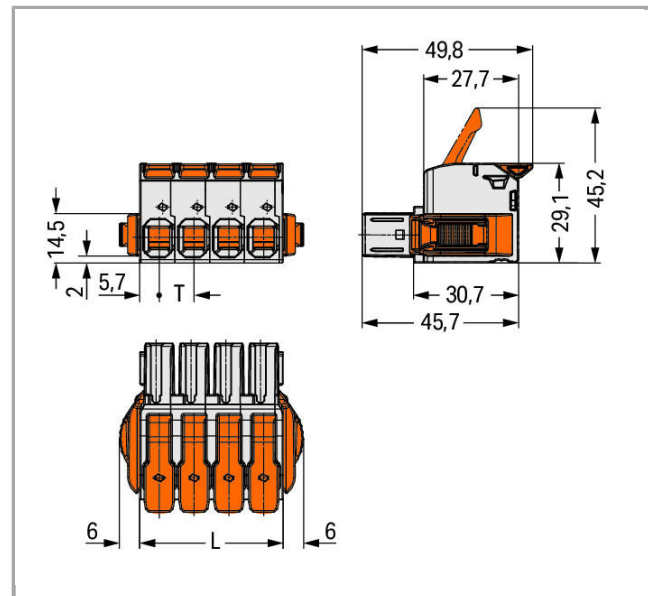
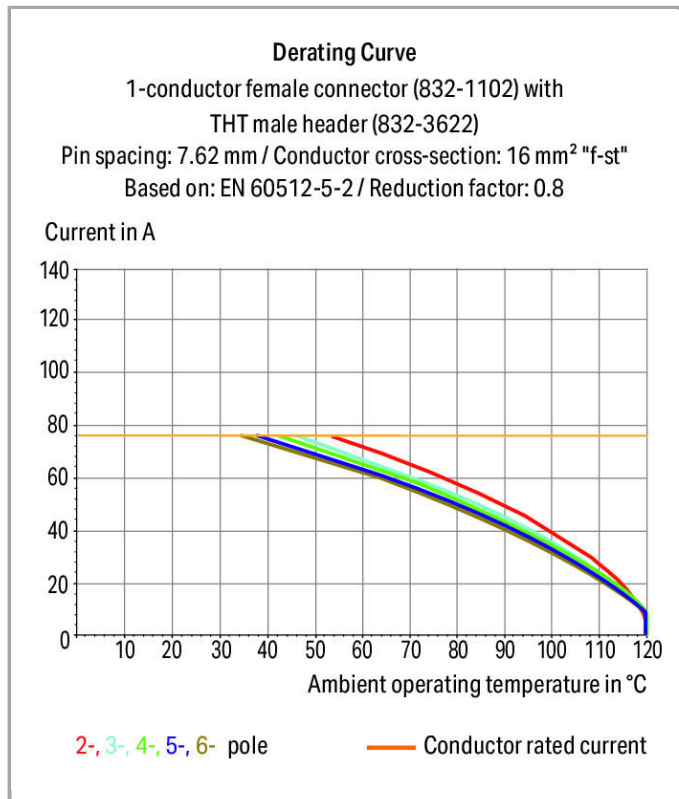

Item description

- Intuitive and tool-free lever actuation
- Universal connection for all conductor types
- Push-in terminations of solid and ferruled conductors
- Test slot 0° and 90° to conductor entry
- 100% protected against mismatching
- Coding via coding fingers

Safety information 1:

The *MULTI CONNECTION SYSTEM (MCS)* is designed without breaking capacity for compliance with DIN EN 61984. When used as intended, MCS Connectors shall not be connected/disconnected when live or under load. The circuit design should ensure header pins, which can be touched, are not live when unmated.

Data

Electrical data

Ratings per IEC/EN 60664-1

Rated voltage (III / 3)	1000 V
Rated impulse voltage (III / 3)	8 kV
Rated voltage (III / 2)	1000 V
Rated impulse voltage (III / 2)	8 kV

Rated voltage (II / 2)	1000 V
Rated impulse voltage (II / 2)	8 kV
Rated current	76 A

Connection data

Connection technology	Push-in CAGE CLAMP®
Actuation type	Push-button
Solid conductor	0.75 16 mm ² / 18 4 AWG
Fine-stranded conductor	0.75 25 mm ² / 18 4 AWG
Fine-stranded conductor with ferrule with plastic collar	0.75 16 mm ²
Fine-stranded conductor with ferrule without plastic collar	0.75 16 mm ²
Strip length	18 20 mm / 0.71 0.79 inch
Total number of connection points	4
Total number of potentials	4
Number of connection types	1
Number of levels	1
No. of poles	4

Geometrical Data

Pin spacing	10.16 mm / 0.4 inch
Width	53.94 mm / 2.124 inch
Height	29.1 mm / 1.146 inch
Depth	49.8 mm / 1.961 inch

Plug connection

Contact type (pluggable connector)	Female connector/socket
Connector connection type	for conductors
Mismating protection	Yes
Locking of plug-in connection	locking lever

Material Data

Color	light gray
Material group	I
Insulating material	Polybutylene terephthalate (PBT)
Flammability class per UL94	V0
Clamping spring material	Chrome nickel spring steel (CrNi)
Material of the additional spring for socket contact	Chrome nickel spring steel (CrNi)
Contact material	Electrolytic copper (E _{Cu})
Contact plating	silver-plated

Weight	55.584 g
--------	----------

Environmental Requirements

Limit temperature range	-60 +120 °C
-------------------------	-------------

Commercial data

Country of origin	DE
GTIN	4055143736794
Customs Tariff No.	85366990990

Approvals / Certificates

Radio-Approvals

Logo	Approval	Additional Approval Text	Certificate name
	CSA	C22.2	70180346

Country specific Approvals

Logo	Approval	Additional Approval Text	Certificate name
	CSA DEKRA Certification B.V.	C22.2	70180346

Other Approvals

Logo	Approval	Additional Approval Text	Certificate name
	cURus Underwriters Laboratories Inc.	C22.2 No. 158	E45172

UL-Approvals

Logo	Approval	Additional Approval Text	Certificate name
	cURus Underwriters Laboratories Inc.	C22.2 No. 158	E45172



Compatible products

Coding



Item no.: 832-500
Coding key carrier; orange

832-500

Downloads

Documentation

Additional Information

Technical explanations	Apr 3, 2019	pdf 3.6 MB	Download
------------------------	-------------	---------------	----------

CAD/CAE - Smart Data

CAD data

3D Download 832-1104/037-000	URL	Download
------------------------------	-----	----------

Subject to changes.